

Data Sheet



Article number: 51503429130010

Description: Vibration damper GP-1I 100x80
M12, NR shore 57

Measures

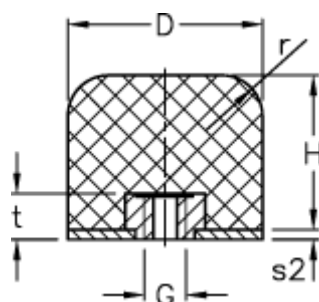

D	= 100	t = 12
d2	= 4	
G	= M12	
H	= 80	
Load capacity F (kN)	= 95.0	
Load capacity f (mm)	= 44	
Load capacity W (J)	= 1120	
r	= 20.0	